

POWYS
Energy Analyzer



**USER
MANUAL**

Klemsan[®]

TABLE OF CONTENTS

SECTION 1	GENERAL INFORMATION	5
1.1	General Features	5
1.2	Power Use and Safety Conditions	6
1.3	Connection Types	7
1.4	General View&Definitions.....	7
1.5	Icons&Leds	8
1.6	Buttons&Their Functions	8
1.7	Menu Structure	9
1.8	Four Quadrant Representation.....	13
SECTION 2	INSTALLATION	14
2.1	Preparation for Installation	15
2.2	Mounting.....	15
2.3	Connection Diagrams	15
2.3.1	Connections	15
2.3.2	Digital Output Connection Diagram	16
2.4	Dimensions (mm)	17
SECTION 3	MENUS	18
3.1	Instantaneous Measurements	19
3.2	Maximum, Minimum and Demand Values	19
3.3	Energy Meters (Energy Menu)	20
3.4	Prevalue Assignme	21
3.5	Saving Procedure.....	21
3.6	Counters Menu.....	22
3.7	Settings Menu.....	23
3.8	Value Changing	28
3.9	Main Settings (Basic)	28
3.10	Alarm Settings (Alarms).....	28
3.11	Demand Time Setting (Demand).....	29
3.12	RS485 Setting (RS485).....	29
3.13	Digital Output Settings (Dig Out)	30
3.14	Pulse Output Settings (Pulse).....	30
3.15	Password Settings (Security)	31
3.16	Display Settings (Display)	31
3.17	Clear Menu (Clear).....	32
3.18	Confirmation Procedure	33
SECTION 4	RS485 COMMUNICATION	34
4.1	Applying Multiple Option Settings With Modbus	40
4.2	Status Flags.....	41
SECTION 5	FACTORY PREVALUES AND SETTING RANGES.....	42
SECTION 6	TECHNICAL SPECIFICATIONS.....	47

FIGURES

Fig. 1-1	Connections	7
Fig. 1-2	General view of the device.....	7
Fig. 1-3	LCD icon descriptions	8
Fig. 1-4	Segment display LED descriptions.....	8
Fig. 1-5	Four Quadrant Representation.....	13
Fig. 2-1	Connection Diagram	16
Fig. 2-2	Digital Output Connection Diagram (POWYS 10xx).....	16
Fig. 2-3	Dimensions.....	17
Fig. 3-1	Example of instantaneous measurement page (Reactive power)....	19
Fig. 3-2	Example of demand page (Active power)	20
Fig. 3-3	Example of Import Active Energy Meter Display	21
Fig. 3-4	Save Prosedure	22
Fig. 3-5	Counters Menu.....	23
Fig. 3-6	Alarm Example(Alarm delay is set to be zero).....	29
Fig. 3-7	Confirmation Prosedure.....	33

TABLES

Table 1-1	Button functions.....	9
Table 1-2	Instantaneous measurements and submenus (LCD devices)	10
Table 1-3	Instantaneous measurements and submenus (7-Segment devices)....	11
Table 1-4	Energy, counter, harmonics and settings menus.....	12
Table 3-1	SETTINGS Menu tree	28
Table 4-1	MODBUS table.....	40
Table 5-1	Factory Prevalu.....	46
Table 6-1	Measurement Accuracy.....	49



POWYS
Enerji Analizörü

**SECTION 1
GENERAL
INFORMATION**

SECTION 1 GENERAL INFORMATION



1.1 General Features





POWYS 1xxx series is an energy analyzer designed for single phase systems, measuring the following parameters:

- Voltage
- Current
- Network frequency
- CosØ value
- Power factor
- Active power
- Reactive power
- Apparent power
- THDV
- THDI
- Voltage and current harmonics between 1-31

In addition to the measurement features, it also executes the following functions:

- Import active, export active, import reactive, export reactive energy meters
- Demand values for current, active power, reactive power and apparent power are calculated and stored in its memory.
- Establishes and stores in its memory the maximum and minimum values reached by current, voltage, frequency, cosØ, power factor, THDV, THDI, active, reactive and apparent powers
- Assigns alarms for current, voltage, frequency, cosØ and power factor parameters
- Keeps the on hour, run hour and number of power interruption
- CTR setting that may be entered from 1 to 5000
- VTR setting that may be entered from 0.1 to 5000
- RS485 communication that may be adjusted from 1200 to 57600 baud (POWYS 11xx)
- Communication with MODBUS RTU (POWYS 11xx)
- 2 pulse outputs can be used for high and low alarm outputs(POWYS 10xx)
- Pulse outputs that may be assigned to the energy values as output parameter (POWYS 10xx)
- Unauthorized access protection with 4 digit user password
- Adjustable automatic menu browsing feature

- Adjustable LCD backlight on duration
- Sealable cover
- Low power consumption
- A wide range of feeding and operating temperature

					
Device model	POWYS 1110	POWYS 1012	POWYS 1120	POWYS 1022	POWYS 1023
Order number	606 351	606 354	606 352	606 355	606 356
Connection	Rail mount	Rail mount	Rail mount	Rail mount	Rail mount
Basic Measurements	•	•	•	•	•
Minimum-maximum value storage	•	•	•	•	•
Demand Measurements	•	•	•	•	•
LCD	-	-	•	•	•
7 segment displays and LEDs	•	•	-	-	-
Energy Digit Display	8+0 (XX XXX XXX)	8+0 (XX XXX XXX)	8+0 (XX XXX XXX)	8+0 (XX XXX XXX)	7+1 (XX XXX XX.X)
Alarm Definition	•	•	•	•	•
RS485 Communicaiton	•	-	•	-	-
Digital output that may be assigned to pulse or alarm	-	2 pcs	-	2 pcs	2 pcs

1.2 Poper Use and Safety Conditions

- Installation and connections should be established in accordance with the instructions set out in the manual by authorized persons. Unless the connection is built properly, device should not be operated.
- Before wiring the device up, make sure that energy is cut off
- Do not disconnect the POWYS current transformer connection before short circuiting the k-1 tips of the current transformer somewhere else. Otherwise, dangerous high voltages may emerge at the secondary tips of the current transformer.
- Use a dry cloth to remove the dust from the device/clean the device. Avoid using alcohol, thinner or a corrosive material.
- Device should be engaged only after all the connections are made.
- Do not open the inside of the device. There are no parts which the users can intervene inside.

- Device should be kept away from humid, wet, vibrant and dusty environments.
- It is recommended to connect a breaker or automatic fuse (2 amper) between the voltage inputs of the device and the network.



The manufacturing company may not be kept responsible for unfavorable incidents that arise out of the failure to follow the above cautions.

1.3 Connection Types

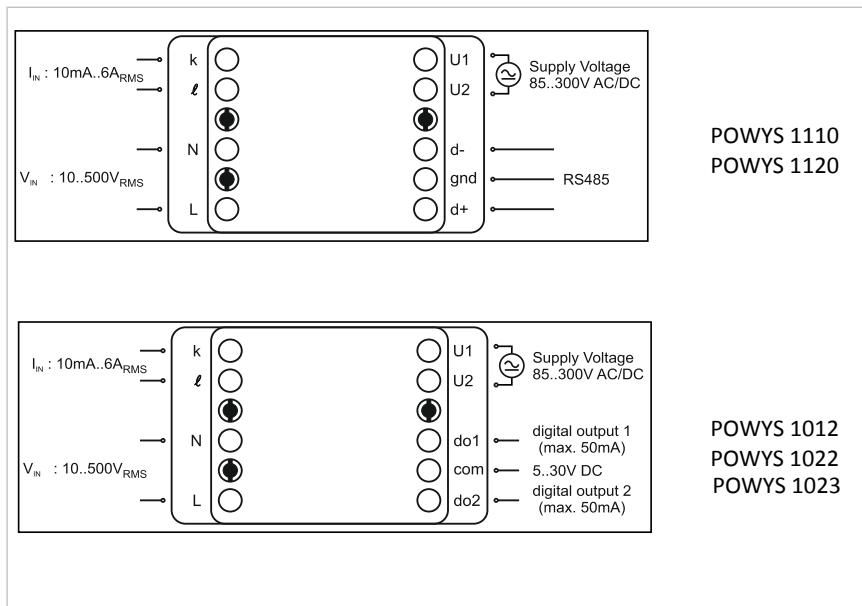

Fig. 1-1 Connections

1.4 General View & Definitions

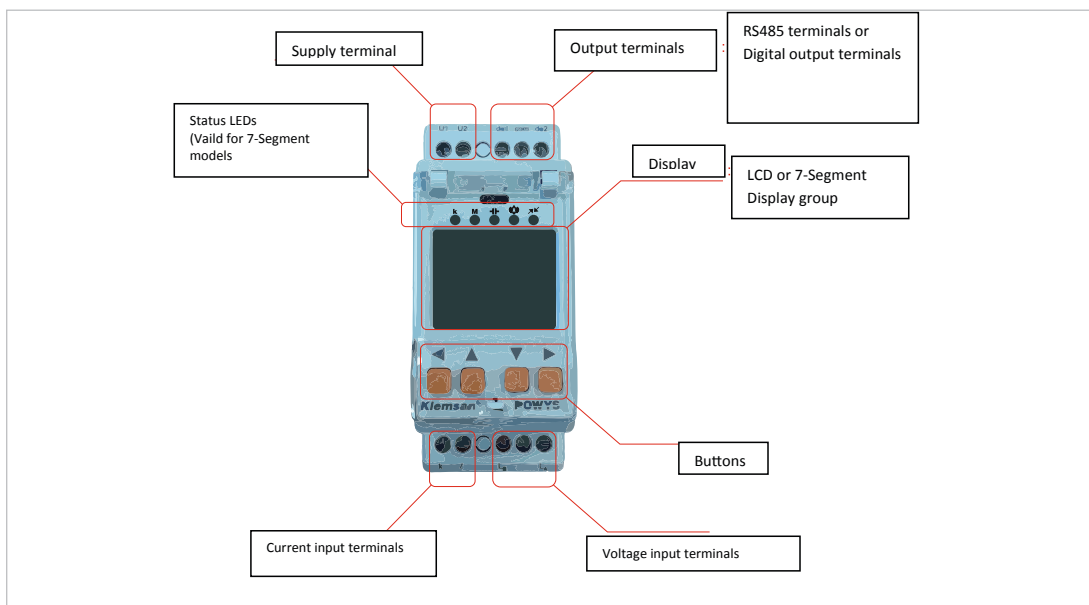

Fig. 1-2 General view of the device

1.5 Icons&Leds

The descriptions of the icons appearing on the display of the devices with LCD are provided as follows:





Imp	activated when the import meters are shown
Exp	activated when the reactive meters are shown
act	activated when the active meters are shown
rea	activated when the reactive meters are shown
run	activated when the total run hour is shown
on	activated when the total on hour is shown
int	activated when the total number of power interruptions is shown
max	activated when the maximum values are shown
min	activated when the minimum values are shown
demand	activated when the demand values are shown
kVArh	unit of the reactive meters
kWh	unit of the active meters
	activated when giving pulse from the 1st pulse output
	activated when giving pulse from the 2nd pulse output
	activated during RS485 communication
	activated if the value shown is inductive
	activated if the value shown is capacitive

Fig. 1-3 LCD icon descriptions

For 7-segment display devices, the flash status of LEDs located in the upper part of the display is described as below:





k	shows that value written on the display is divided into 1000
M	shows that value written on the display is divided into 1000000
	if the value shown is capacitive, it gets activated
	shows that at least 1 alarm is present
	activated when giving a pulse from any one of the pulse outputs
	activated during RS485 communication

Fig. 1-4 Segment display LED descriptions

1.6 Buttons&Their Functions

The buttons valid on the front panel and their functions are described on the following table:

	In the MEASUREMENTS menus		In the ENERGY, COUNTER, HARMONICS, SETTINGS menus		ASSIGNING PRE VALUES TO THE METERS		CHANGE SETTINGS	
	SHORT PRESSING (t < 2sec)	LONG PRESSING (t > 2sec)	SHORT PRESSING (t < 2sec)	LONG PRESSING (t > 2sec)	SHORT PRESSING (t < 2sec)	LONG PRESSING (t > 2sec)	SHORT PRESSING (t < 2sec)	LONG PRESSING (t > 2sec)
RIGHT	Switches between menus	Skips to the "ENERGY" menu	Switches to the submenu	Skips to the menu at the bottom	Changes the active digit	Activates changing value	Activates changing value or changes the active step	No effect
DOWN	Switches between menus	No effect	Switches between menus	No effect	Changes value	No effect	Changes value	No effect
UP	Switches between menus	No effect	Switches between menus	No effect	Changes value	No effect	Changes value	No effect
LEFT	Switches between menus	Skips to the homepage	Switches between menus	Skips to the most recent menu in the measurements menu	Stops changing value and confirms the value entered	No effect	Stops changing value and confirms the value entered	No effect

Table 1-1 Button functions

1.7 Menu Structure

Instantaneous measurement menus and the menus showing their related maximum, minimum and demand values are provided in the following table. As provided in the table, down, up, right and left handside buttons provide menu switches.

	menu		max		min		demand	
	↕		↕		↕			
↔	VOLTAGE	↔	max	↔	min	↔		↔
	↕		↕		↕		↕	
↔	CURRENT	↔	max	↔	min	↔	demand	↔
	↕		↕		↕		↕	
↔	FREQ	↔	max	↔	min	↔		
	↕		↕		↕			
↔	COSQ	↔	max	↔	min	↔		
	↕		↕		↕			
↔	PF	↔	max	↔	min	↔		↔
	↕		↕		↕		↕	
↔	POWER P	↔	max	↔	min	↔	demand	↔
	↕		↕		↕		↕	
↔	POWER Q	↔	max	↔	min	↔	demand	↔
	↕		↕		↕		↕	
↔	POWER S	↔	max	↔	min	↔	demand	↔
	↕		↕		↕		↕	
↔	THD V	↔	max	↔	min	↔		
	↕		↕		↕			
↔	THD I	↔	max	↔	min	↔		
	↕		↕		↕			

Table 1-2 Instantaneous measurements and submenus (LCD devices)

	menu		max		min		demand	
	↕		↕		↕			
↔	Uolt	↔	H - U	↔	L - U	↔		↔
	↕		↕		↕		↕	
↔	Curr	↔	H - I	↔	L - I	↔	d - I	↔
	↕		↕		↕		↕	
↔	FrEq	↔	H - F	↔	L - F	↔		
	↕		↕		↕			
↔	coSQ	↔	H - co.	↔	L - co.	↔		
	↕		↕		↕			
↔	PF	↔	H - PF	↔	L - PF	↔		↔
	↕		↕		↕		↕	
↔	Act	↔	H - Ac.	↔	L - Ac.	↔	d - Ac.	↔
	↕		↕		↕		↕	
↔	rEA	↔	H - rE.	↔	L - rE.	↔	d - rE.	↔
	↕		↕		↕		↕	
↔	APr	↔	H - AP	↔	L - AP	↔	d - AP	↔
	↕		↕		↕		↕	
↔	tHdU	↔	H - t.U	↔	L - t.U	↔		
	↕		↕		↕			
↔	tHdI	↔	H - t.I	↔	L - t.I	↔		
	↕		↕		↕			

Table 1-3 Instantaneous measurements and submenus (7-Segment devices)

Energy meters, counters, odd harmonics between 1-31 and menus showing the settings are provided in the following table. As provided in the table, down, up, right and left handside buttons provide menu switches.

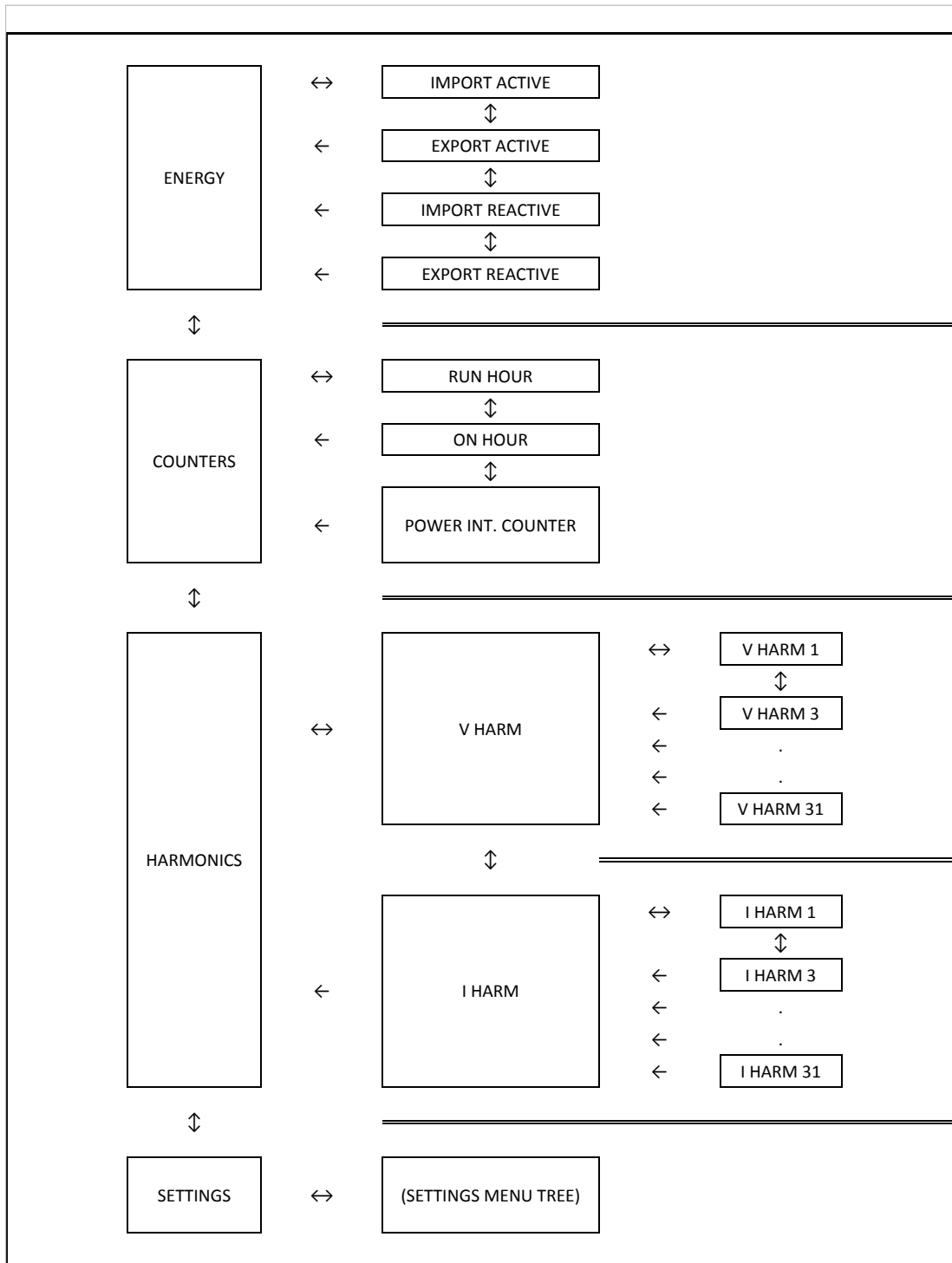

Table 1-4 Energy, counter, harmonics and settings menus

1.8 Four Quadrant Representation

The angle(θ) between voltage and current provides us information about the direction of energy flow. A positive sign for active/reactive power indicates that active/reactive power is consumed. And also a negative sign for active/reactive power indicates that active/reactive power is generated.

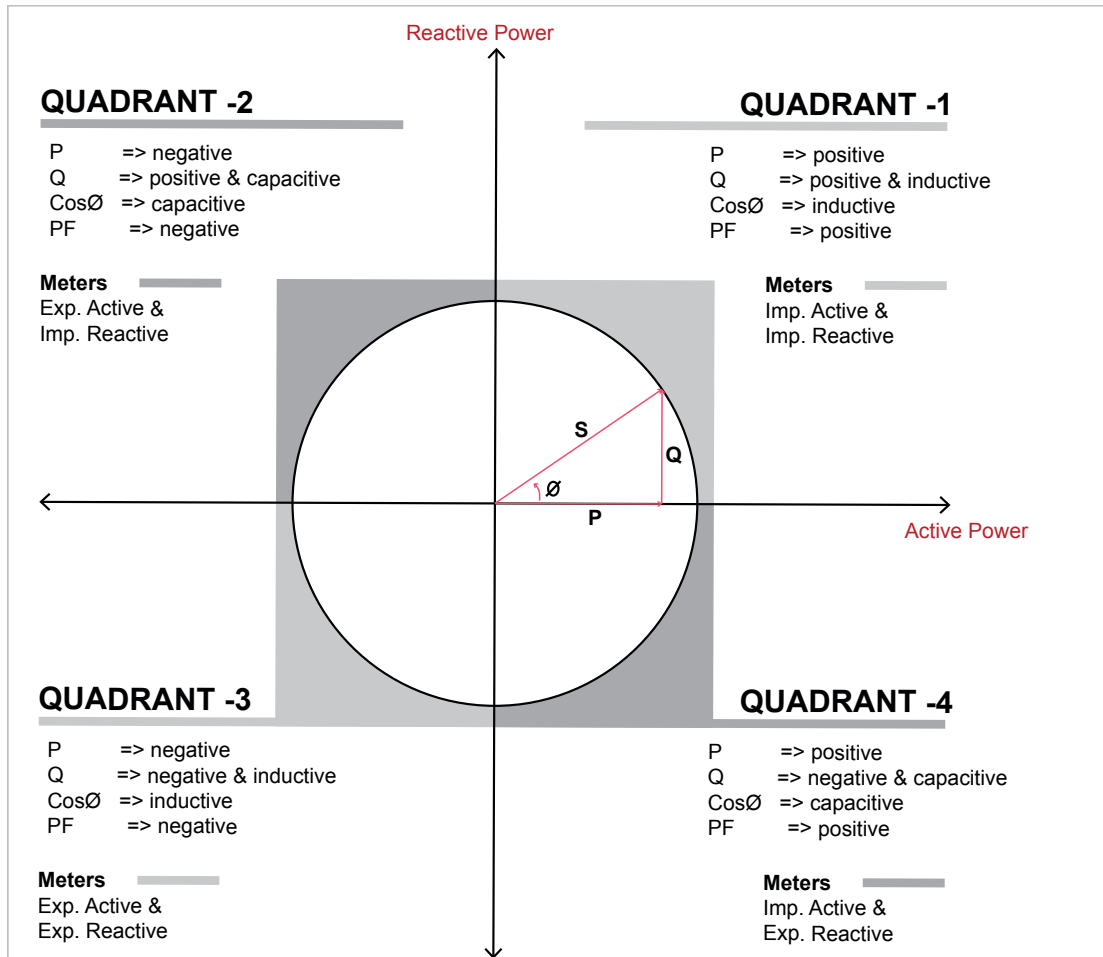

Fig. 1-5 Four Quadrant Representation

NOTE: If the signs of active and reactive power are examined, it can be defined the quadrant that POWYS measures.

In order to understand P and Q signs in POWYS 10xx and POWYS 11xx, instantaneous displays for P and Q must be checked.

If active power display is seen constantly, it means active power(P) is positive. If it is blinked, it means active power(P) is negative.

If reactive power(Q) display is seen constantly, it means reactive power(Q) is positive. If it is blinked, it means reactive power(Q) is negative.

NOTE: Signs of P and Q can be reached through modbus communication.

e.g.;	P= +10kW, Q= +5kVAr	=> Quadrant-1
	P= -10kW, Q= +5kVAr	=> Quadrant-2
	P= -10kW, Q= -5kVAr	=> Quadrant-3
	P= +10kW, Q= -5kVAr	=> Quadrant-4



POWYS
Energy Analyzer

SECTION 2
INSTALLATION

SECTION 2 INSTALLATION

2.1 Preparing for Installation

The purchased product may not include all hardware options referred in this document. This situation does not constitute an impediment to the electrical installation.



Assembly and related connections of the product, must be implemented by authorized persons in accordance with the instructions of user manual.



The device must not be put into service if the operator is not sure that all connections are correctly accomplished.

2.2 Mounting

POWYS 10xx and POWYS 11xx are replaced onto 35mm standart rail.



Before wiring up voltage and current ends to POWYS, you must be sure that the power is cut.



The product is connected to current transformer(s). Before disconnecting current transformer leads, be sure that they are short circuited elsewhere or connected to a parallel load which has sufficiently low impedance. Otherwise dangerously high voltages will be induced at the current transformer leads. Same phenomena also apply for putting into service.

2.3 Connection Diagrams

2.3.1 Connections

POWYS 10xx and POWYS 11xx are replaced onto 35mm standart rail.

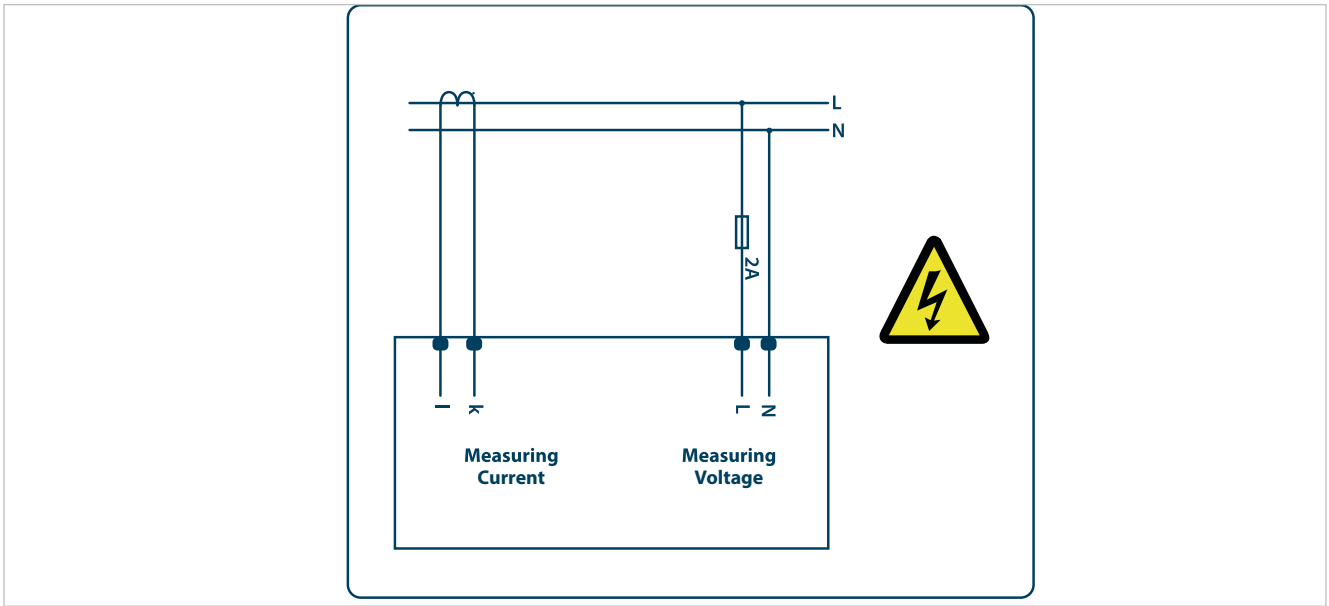

Fig. 2-1 Connection Diagram

2.3.2 Digital Output Connection Diagram

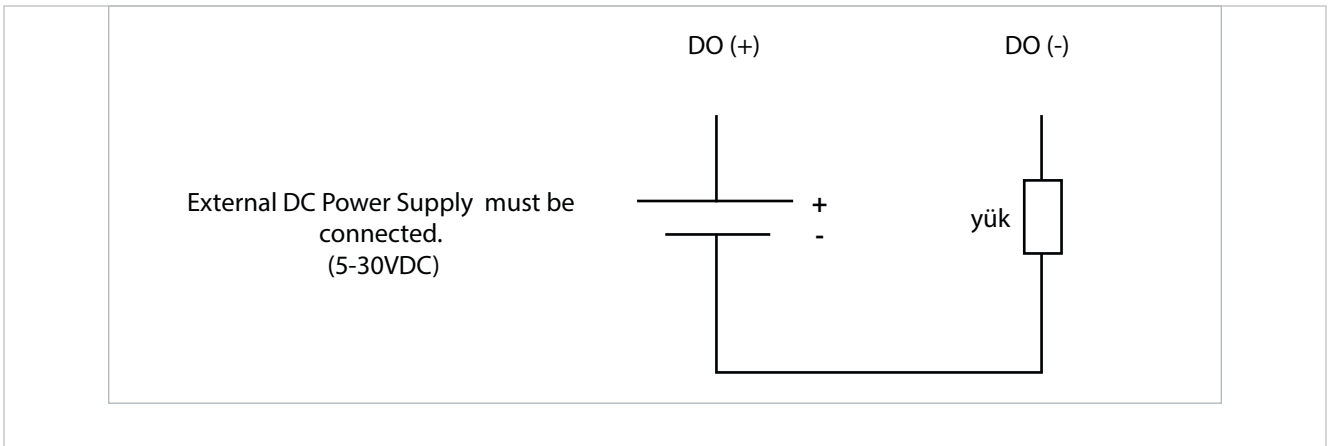

Fig. 2-2 Digital Output Connection Diagram (POWYS 10xx)

2.4 Dimensions (mm)

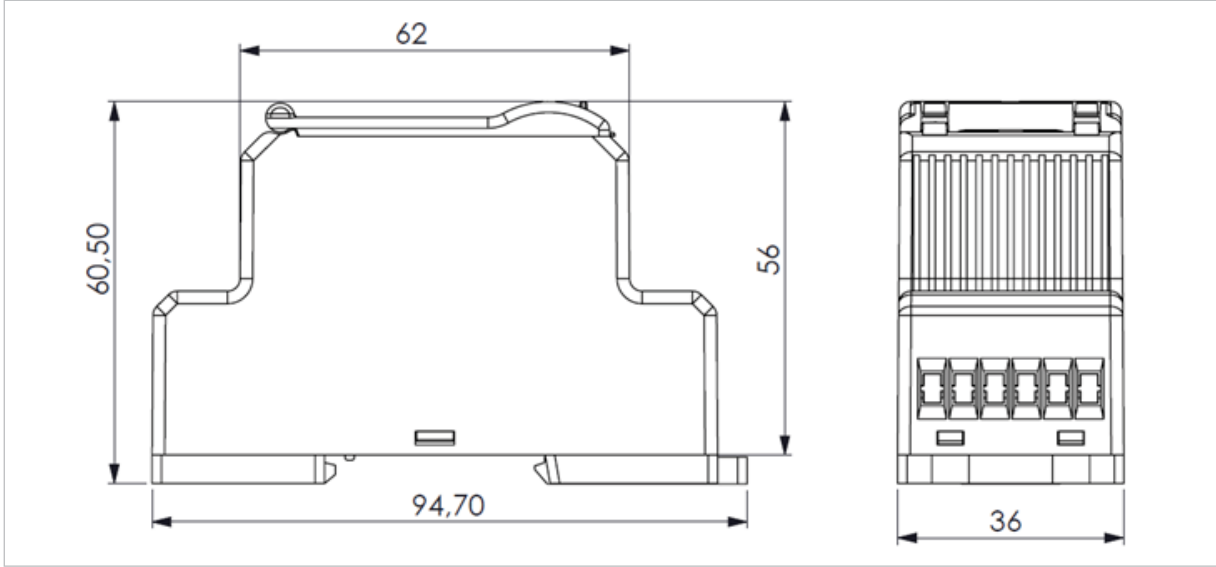

Fig. 2-3 Dimensions



POWYS
Energy Analyzer

SECTION 3
MENUS

SECTION 3 MENUS

3.1 Instantaneous Measurements

Instantaneous measurement menus and the menus showing their related maximum, minimum and demand values are provided in the following table. As provided in the table, down, up, right and left handside buttons provide menu switches.

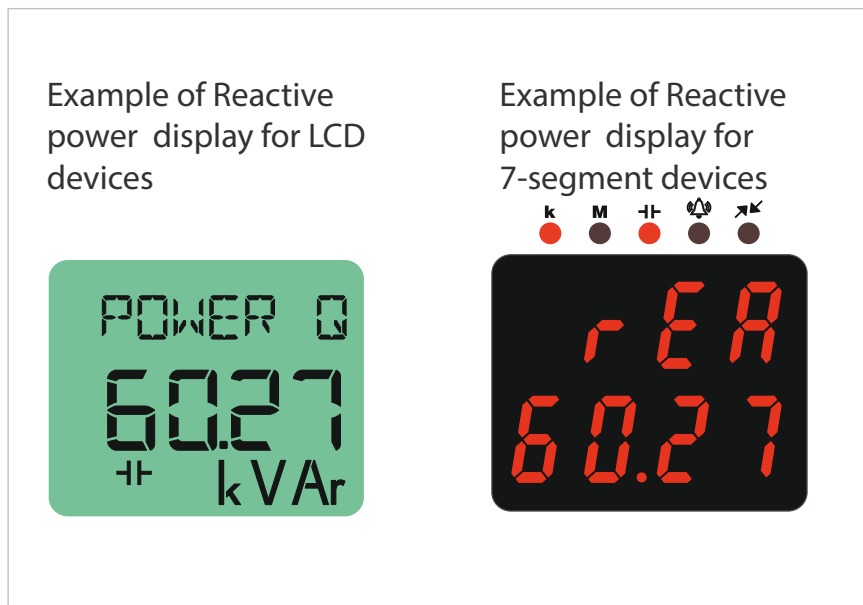

Fig. 3-1 Example of instantaneous measurement page (Reactive power)



“----” icon which appears in the menu showing instantaneous measurement refers to the value being higher than 99 999 999 For Powys 1023, shown in 9 999 999.9 kWh / kVArh format.

3.2 Maximum, Minimum and Demand Values

Minimum and maximum values of the voltage, current, frequency, $\text{Cos}\phi$, power factor, active power, reactive power, apparent power, THDV and THDI parameters as well as the demand values of current, active, reactive and apparent power are calculated by the device and stored in the permanent memory. Right or left handside buttons in the measurement menus display the maximum, minimum measurements and demand values. [Menu switches are shown in the Table 1.2](#)

The values stored in the memory may be selected from the “CLEAR” menu located in the “SETTINGS” menu to be erased. Furthermore, resetting is also possible via resetting or restoring the factory settings commands for devices with RS-485 communication

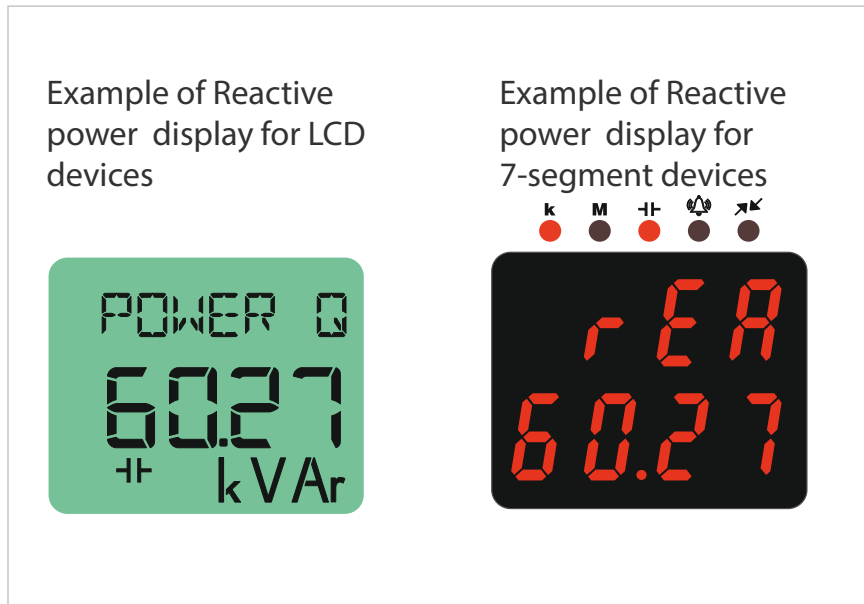

Fig. 3-2 Example of demand page (Active power)



"- - -" icon appearing in the menus which shows minimum values refer to the fact that no value has yet to be saved as a minimum value.

3.3 Energy Meters (Energy Menu)

Under the "ENERGY" menu, import active, export active, import reactive and export reactive meters are valid.

Menu structure is as follows:

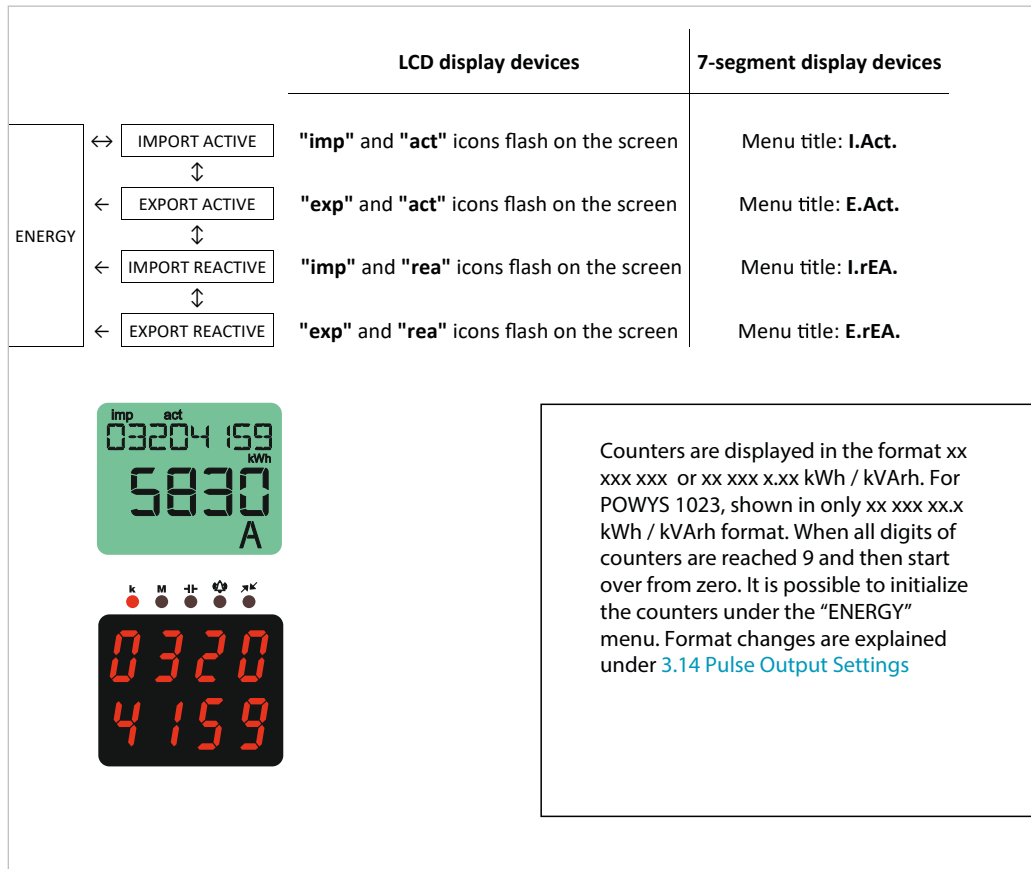

Fig. 3-3 Example of Import Active Energy Meter Display

3.4 Prevalue Assignment

While in a menu to which a value can be assigned, press the right button 2 seconds, the first digit of the related meter will start to blink. Go to the digit you want changed with the right arrow button and enter a value with up/down arrows. When the value entering is completed, confirm the value with the left arrow button. Go to the saving procedure in order to save the changes made. See: Saving procedure.

3.5 Saving Procedure

In order to save or cancel the changes, keep pressing the left button until the "SAVE" screen shows.

If the changes are to be saved:

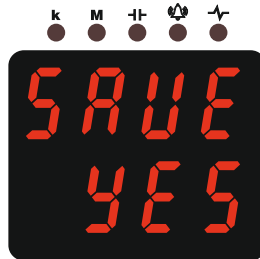

Press the right button so that "NO" sign starts blinking. Pressing the down/up buttons, "NO" sign turns into "YES" sign. Then, pressing the left button, save the changes.

If the changes are to be cancelled:

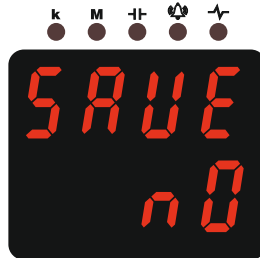

Press the right button so that "NO" sign starts blinking. Then, press the left button to exit the menu without saving the changes made.

Fig. 3-4 Save Procedure

3.6 Counters Menu

The following counters are valid under the "COUNTERS" menu.

- "ON HOUR": The total on hour of the device is counted and shown in the "ON HOUR" counter in hours.
- "RUN HOUR": If current and voltage signals are applied to the related inputs of the device altogether, the time lapsed is counted and shown in hours.
- "POWER INTERRUPTION COUNTER": Shows the number of power interruptions of the device.
- Menu structure is provided below

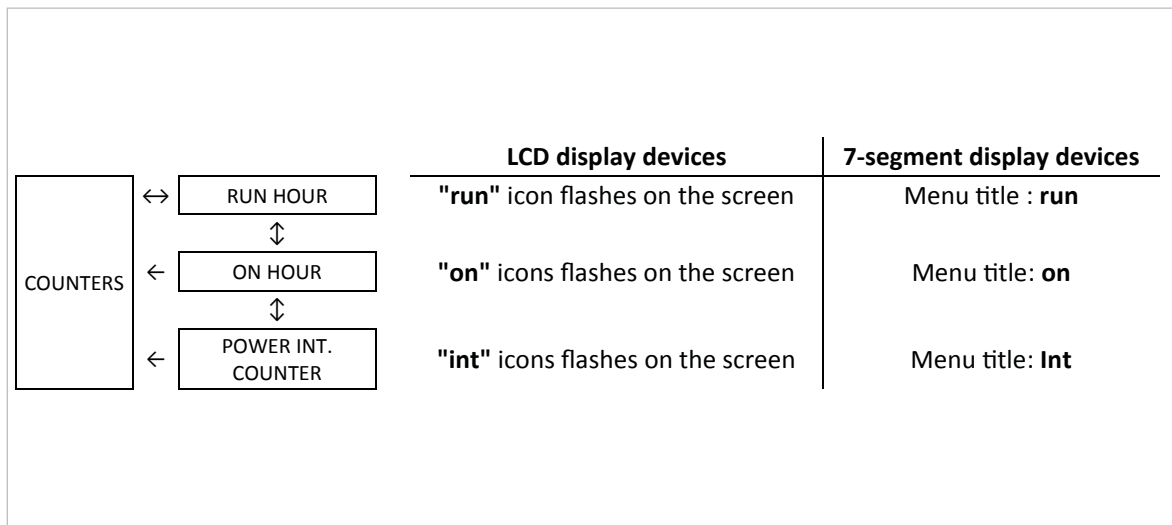

Fig. 3-5 Counters Menu

The counters are shown in 8 digits. All of the counters are resetted after the value 99 999 999 and then continue to count.

Value assignment and resetting only apply to the "RUN HOUR" meter. In order to assign any value to the meter, prevalue assigning procedure is applied. See: Prevalue Assignment

During counter screening, values for the most recent measurement value keep updating in the indicators valid at the bottom. (for LCD devices)

3.7 Settings Menu

The menu tree table for the "SETTINGS" menu which enables device setting is provided below. The screening for 7-segment devices are provided in parantheses.

<i>Menu</i>	Submenu 1	Submenu 2	Submenu 3	Submenu 4	Description		
SETTING S					Settings		
	BASIC (bSc)				Basic settings		
		Ctr			Current transformer ratio		
		Utr			Voltage transformer ratio		
	ALARMS (ALr)	V ALM (Uolt)				Alarm settings	
			HI			Voltage alarm settings	
			LO			Voltage alarm upper limit	
			hYSt			Voltage alarm lower limit	
			dIY.t			Voltage alarm hysteresis value	
			I ALM (Curr)				Current alarm settings
				HI			Current alarm upper limit
				LO			Current alarm lower limit
		hYSt				Current alarm hysteresis value	
				dIY.t		Current alarm delay time	

SETTING S	ALARMS (ALr)	V ALM (Uolt)		Voltage alarm settings
			HI	Voltage alarm upper limit
			LO	Voltage alarm lower limit
			hYSt	Voltage alarm hysteresis value
			dLY.t	Voltage alarm delay time
		I ALM (Curr)		Current alarm settings
			HI	Current alarm upper limit
			LO	Current alarm lower limit
			hYSt	Current alarm hysteresis value
			dLY.t	Current alarm delay time
		COSQ ALM (coSQ)		cos φ alarm settings
			HI	cos φ alarm upper limit
			LO	cos φ alarm lower limit
			hYSt	cos φ alarm hysteresis value
			dLY.t	cos φ alarm delay time
		PF ALM (PF)		Power factor alarm settings
			HI	Power factor alarm upper limit
			LO	Power factor alarm lower limit
			hYSt	Power factor alarm hysteresis value
			dLY.t	Power factor alarm delay time
	FREQ ALM (FrEq)		Frequency alarm settings	
		HI	Frequency alarm upper limit	
		LO	Frequency alarm lower limit	
		hYSt	Frequency alarm hysteresis value	
		dLY.t	Frequency alarm delay time	
	DEMAND (dEd)		Demand value	
		dEd.t	Demand time setting	
	RS485 (485)		RS485 setting (ATTENTION! : This menu is only valid for devices with RS485 output)	
		bAud	Baud rate options	
		Id	Slave ID setting	
		PrtY		Parity control setting
			NONE	Parity control off
			EVEN	Even parity
		ODD	Odd parity	

	DIG OUT (dOut)	OUT1 (Out1)	tYPE	Digital output options (ATTENTION! : This menu is only valid for devices with digital output)	
				1st digital output settings	
				1st digital output type settings	
				OFF	Off
				PULSE (PuLS)	Assign as pulse output
		LOW ALM (ALr.L)	Assign as low alarm output		
		HIGH ALM (ALr.H)	Assign as high alarm output		
		OUT2 (Out2)	tYPE	2nd digital output settings	
				2nd digital output type settings	
				OFF	Off
	PULSE (PuLS)			Assign as pulse output	
	LOW ALM (ALr.L)			Assign as low alarm output	
	HIGH ALM (ALr.H)	Assign as high alarm output			
	PULSE (PuLS)	OUT1 (Out1)	out	Pulse output settings (ATTENTION! : This menu is only valid for devices with digital output)	
				1st pulse output setting	
				1st pulse output parameter setting	
				OFF	Off
				IMP ACT (I.Act.)	Assign to the import active energy meter
				EXP ACT (E.Act.)	Assign to the export active energy meter
				IMP REA (I.rEA.)	Assign to the import reactive energy meter
				EXP REA (E.rEA.)	Assign to the export reactive energy meter
				durA	Pulse duration of the 1st pulse output
				rAt	1st pulse output step range
		OUT2 (Out2)	out	2.pulse output setting	
				2nd oulse output parameter setting	
				OFF	off
				IMP ACT (I.Act.)	Assign to the import active energy meter
				EXP ACT (E.Act.)	Assign to the export active energy meter
				IMP REA (I.rEA.)	Assign to the import reactive energy meter
				EXP REA (E.rEA.)	Assign to the export reactive energy meter
durA				Pulse duration of the 2nd pulse output	
rAt				2nd pulse output step range	
SECURITY (PIn)	Act	Password protection setting			
		Activate/deactivate the password protection			
		NO	Password protection passive		
		YES	Password protection active		

	INFO (InFo)				Informing
		UEr			Firmware version information

Table 3-1 SETTINGS Menu tree

3.8 Value Changing

There are 2 different value changing menus:

- **Multiple choice menus:** These menus enable predefined options. In these menus, press the right button so that the first option of the menu starts to blink. Press the up/down buttons so that the option starts blinking in the screen. Then, press the left button to complete the selection.
- **Menus where digital values are entered:** Browsing among the steps, this menu enables to set the value of your choice. Press the right button so that the first step from the left of the variable starts blinking. Right button enables to switch among the steps. Press the up/down buttons to change the value on the active step. When the values on the step are set and the variable is set to the number of your choice, press the left button to complete the selection.



If a change is made in the settings, when you return to the "SETTINGS" menu, saving procedure is enabled asking whether or not to save the changes. See: Saving Procedure. If the changes are saved, the device is restarted.

"SETTINGS" menu includes the following subtitles:

3.9 Main Settings (Basic)

This menu enables to set the current transformer ratio and voltage transformer ratio. See table 4 for the menu tree, table 6 for step ranges.

Current transformer ratio (Ctr): Current measured via current inputs is multiplied by the current transformer ratio (Ctr) and shown in the indicators and modbus addresses.

Voltage transformer ratio (Vtr): Voltages measured via voltage inputs is multiplied by the voltage transformer ratio (Vtr) and shown in the indicators and modbus addresses.

3.10 Alarm Settings (Alarms)

This menu enables to set the alarm limits, hysteresis value and alarm delay times. See table 4 for the menu tree, table 6 for the step ranges.

If you go outside of the alarm limit values:



- The value in the indicator for the related parameter starts blinking.
- Alarm icon or alarm LED is enabled on the display at the end of the delay time.
- If nothing has  been assigned to the digital output, related output is enabled at the end of the alarm delay time.

Alarm example:

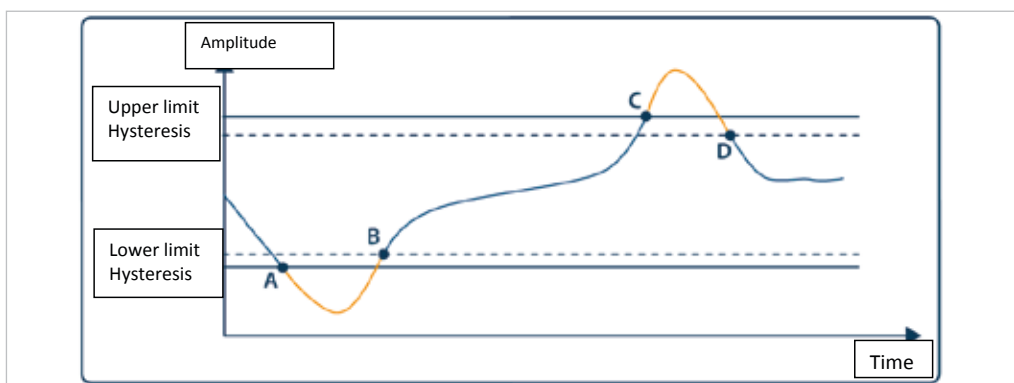

Fig. 3-6 Alarm Example(Alarm delay is set to be zero)

- Low limit alarm occurs at the A point
- Alarm disappears at the B point.
- High limit alarm occurs at the C point
- Alarm disappears at the D point.

3.11 Demand Time Setting (Demand)

This menu enables to set the demand time. See table 4 for the menu tree, table 6 for the setting range. The demand values calculated by the device is calculated throughout the time set in this menu and this activity continuous periodically.

3.12 RS485 Setting (RS485)

(ATTENTION! : This menu is only valid for devices with RS485 output)

This menu enables to set baudrate, slave ID and parity control used in RS485 communication. See table 4 for the menu tree and table 6 for the setting ranges.

Baudrate (bAud):

Refers to the signal rate used in communication in terms of "baud". Communication rate may be modified within the range of setting.

**Slave ID (Id):**

RS485 communication works based on the communication of one master and one or more than one slave devices. POWYS responds to the queries made by the master as a slave in the RS485 communication. The slave rank of the device in this communication may be set in the Slave ID menu.

Parity Control (PrtY):

It is a mechanism controlling the data accuracy, which is commonly used in communication. It works based on the principle of counting "1" within the binary data. It has "even" or "odd" parity control methods. In order to communicate, master and slave devices have to use the same method. The method of your choice is selected in this menu or parity control feature is turned off by selecting the "NONE" option.

3.13 Digital Output Settings (Dig Out)

(ATTENTION! : This menu is only valid for devices with digital output.)

This menu enables to turn on/off and to select the type of the digital outputs. See the menu tree for table 4 and table 6 for the step ranges.

Digital output type (tYPE):

- Option to assign to the pulse output (PULSE) : In order to use the related output as pulse output, this option has to be selected first. Then, the necessary settings out of pulse output settings can be adjusted so that the pulse output is activated.
- Option to assign to the low alarms (LOW ALM) : If this option is selected as a digital output type, in case of a preset low alarm, the related output is activated.
- Option to assign to the high alarms (HI ALM) : If this option is selected as a digital output type, in case of a preset high alarm, the related output is activated.

3.14 Pulse Output Settings (Pulse)

This menu is used to set on / off position, output parameters, pulse duration and step range for the pulse outputs. Output parameters can be adjusted according to energy values and digital input. Settings for both pulse outputs can be made separately. See Table 4 for the menu tree and SECTION 6 for the factory default settings.

Pulse outputs become active whenever the adjusted output parameter is increased by each step range and remain in this position for a set time and then deactivate.

Output parameter setup (OUT):

It is the menu that used to set the output depending on which parameter. If "OFF" option is selected, related outputs are closed.

NOTE:

CT – VT ratios are included in the index calculations and energy values are in kWh and kVArh unit by default. These values can be changed via the Monalyzer or the addresses specified in the Modbus register table. In case of a change, new settings become active after the “save changes” command is sent.



- If “0” is written in 900th Modbus address, CT - VT ratios are included in index calculations and outputs give pulses in kWh and kVArh units.
- Due to “1” is written in 900th Modbus address, CT - VT ratios will not be included in the index calculations and outputs give pulses in Wh and VArh units.

In POWYS 1023, it can only be output according to kWh / kVArh unit.

Pulse duration setup (durA):

It is the menu where the duration of the pulse is set.

Pulse step range (rAt):

It is the menu where the smallest amount of increase of input parameter to be pulse is set.

3.15 Password Settings (Security)

This menu enables to turn on/off the password protection status, and adjust the settings for the password activation duration and password change settings.

In order to protect the device setting and meter menus against unauthorized entry and changes, there is a 4 step password protection. If the password is in active position, when any value is tried to be changed, the password query display shows up. After entering the password, the password is not requested again until the “password activation time” is up. This duration of time may be adjusted via the related menu. See table 4 for the menu tree and table 6 for the setting ranges.



If no button is pressed after entering the password or no setting change is made via Modbus communication, password protection is enabled again at the end of the password activation duration.

3.16 Display Settings (Display)

This menu enables to adjust the menus and display backlight setting.

Menu Settings (MENU):

This is the subtitle enabling the menu browsing setting, screening duration and homepage setting.

- **Menu browsing setting (ScrL):** When the menu on the display is automatically changed at the end of the set screening duration and switched to the next menu, it is called menu browsing.



If the "ON" option is selected, 15 seconds after the device is turned on or a button is pressed, automatic menu browsing is enabled. When the menu screening duration is up, the next menu starts to show on the display (as if the down arrow button is pressed). As long as no other button is pressed, browsing keeps on. If the "OFF" option is selected, this feature is turned off.

- **Menu screening duration (Scr.P):** While the menu browsing mode is on, this menu enables to determine the screening duration of each menu in seconds. When the browsing mode is off, it has no effect.

- **Homepage setting (Strt):** When the device is powered, it is the first menu opening page that will come to the display. In this menu, any of the Instantaneous measurement menus may be set as a homepage. As a prevalue, "VOLTAGE" menu is set to be the homepage.

Display backlight setting (BACKLGHT):

(ATTENTION! : This menu is only valid for devices with LCD)

It is the subtitle enabling to set the display backlight options and backlight on time.

- **Display backlight options (oPt):** This menu enables to set the display backlight either to be time dependent or continuously on or continuously off.
- **Time dependent (TIME DEP):** When the device is powered or any button is pressed, the display light is on; if no other button is pressed, the backlight is turned off at the end of the display backlight on time. This option is preferred due to energy saving and lighting LEDs with longer shelf life.
- **CONTINUOUSLY ON (CONT ON)::** The display backlight stays continuously on.
- **CONTINUOUSLY OFF (CONT OFF)::** The display backlight stays continuously off.

- **Display backlight on time (durA):** This menu enables to set the duration used in the time dependent option for the display backlight in seconds

3.17 Clear Menu (Clear)

This menu enables to clear the values stored in the device memory and restore the settings to the factory settings. The below options are valid under the clear menu.

- **OFF:** Used to cancel the clearing activity
- **ALL :** Used to clear all the values stored in the memory and restore all the settings to the factory settings.
- **ENERGY :** Used to reset all the energy meters.
- **COUNTERS :** Used to reset all the counters.
- **MAX VALS :** Used to clear the maximum values stored in the memory.
- **MIN VALS :** Used to clear the minimum values stored in the memory.
- **DEMAND :** Used to clear the demand values stored in the memory.
- **SETTINGS :** Used to restore all the settings to the factory settings.
- **ALARMS :** Used to restore the alarm settings to the factory settings.

When an option other than the OFF one is selected, the “Confirmation Procedure” appears on the screen in order to avoid any accidental clearing.

3.18 Confirmation Procedure

The following query appears on the display to confirm or cancel the activity to apply:

To confirm the activity:

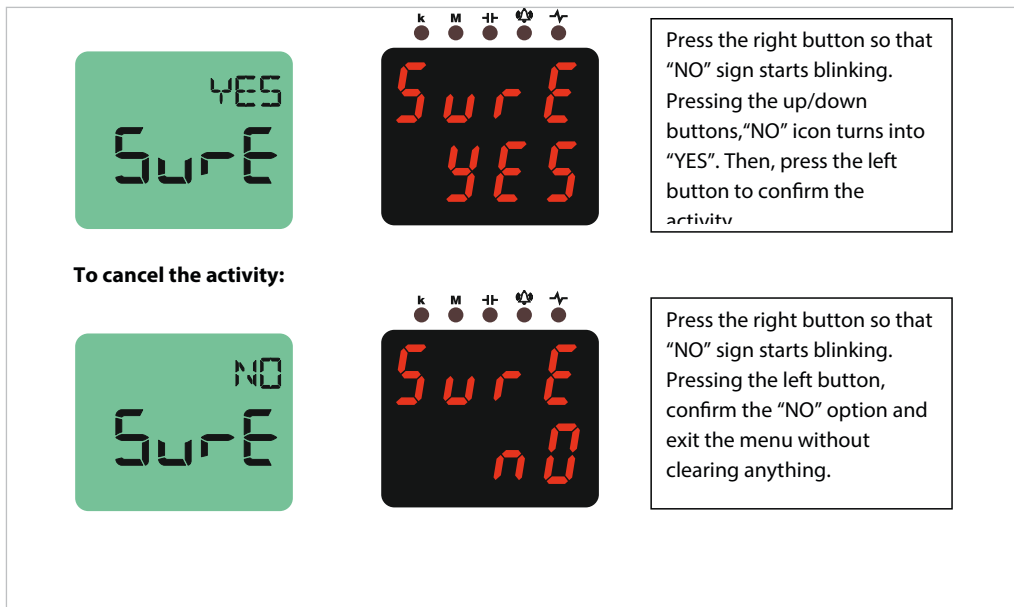

Fig. 3-7 Confirmation Procedure



After selecting and confirming the options SETTINGS, ALARMS or ALL in the clear menu, the device will restart itself. There is no restarting for the other options. The device clears and goes back to the CLEAR menu.



POWYS
Energy Analyzer

**SECTION 4 RS485
COMMUNICATION**

SECTION 4 RS485 Communication

RS485 communication is built by using the “MODBUS RTU” protocol. The functions that are supported are as follows:

- 03H function: Readable addresses can be read with using this function in the modbus table.
- 10H function: Writable addresses can be written with using this function in the modbus table.

Definitions:

- R / W : The value in this address can be read and written.
- RO : The value in this address can only be read.
- WO : This address only allows writing.
- float : 32 bit float number.

Modbus table is provided below:

address	register name	type	reading / writing	Writing condition
40001	Voltage	float	RO	
40003	Current	float	RO	
40005	Frequency	float	RO	
40007	Cosp	float	RO	
40009	Power factor	float	RO	
40011	Active power	float	RO	
40013	Reactive power	float	RO	
40015	Apparent power	float	RO	
40017	THDV	float	RO	
40019	THDI	float	RO	
40021	Voltage Harmonic - 1	float	RO	
40023	Voltage Harmonic - 3	float	RO	
40025	Voltage Harmonic - 5	float	RO	
40027	Voltage Harmonic - 7	float	RO	
40029	Voltage Harmonic - 9	float	RO	
40031	Voltage Harmonic - 11	float	RO	
40033	Voltage Harmonic - 13	float	RO	
40035	Voltage Harmonic - 15	float	RO	
40037	Voltage Harmonic - 17	float	RO	
40039	Voltage Harmonic - 19	float	RO	
40041	Voltage Harmonic - 21	float	RO	
40043	Voltage Harmonic - 23	float	RO	
40045	Voltage Harmonic - 25	float	RO	
40047	Voltage Harmonic - 27	float	RO	
40049	Voltage Harmonic - 29	float	RO	
40051	Voltage Harmonic - 31	float	RO	
40053	Current Harmonic - 1	float	RO	

40055	Current Harmonic - 3	float	RO	
40057	Current Harmonic - 5	float	RO	
40059	Current Harmonic - 7	float	RO	
40061	Current Harmonic - 9	float	RO	
40063	Current Harmonic - 11	float	RO	
40065	Current Harmonic - 13	float	RO	
40067	Current Harmonic - 15	float	RO	
40069	Current Harmonic - 17	float	RO	
40071	Current Harmonic - 19	float	RO	
40073	Current Harmonic - 21	float	RO	
40075	Current Harmonic - 23	float	RO	
40077	Current Harmonic - 25	float	RO	
40079	Current Harmonic - 27	float	RO	
40081	Current Harmonic - 29	float	RO	
40083	Current Harmonic - 31	float	RO	
40085	Max. Voltage	float	RO	
40087	Max. Current	float	RO	
40089	Max. Frequency	float	RO	
40091	Max. Cos ϕ	float	RO	
40093	Max. Power Factor	float	RO	
40095	Max. Active Power	float	RO	
40097	Max. Reactive Power	float	RO	
40099	Max. Apparent Power	float	RO	
40101	Max. THDV	float	RO	
40103	Max. THDI	float	RO	
40105	Min. Voltage	float	RO	
40107	Min. Current	float	RO	
40109	Min. Frequency	float	RO	
40111	Min. Cos ϕ	float	RO	
40113	Min. power Factor	float	RO	
40115	Min. active power	float	RO	
40117	Min. reactive power	float	RO	
40119	Min. apparent power	float	RO	
40121	Min. THDV	float	RO	
40123	Min. THDI	float	RO	
40125	Status flags	32 bit integer	RO	
40127	Current Demand	float	RO	
40129	Active Power Demand	float	RO	
40131	Reactive Power Demand	float	RO	
40133	Apparent Power Demand	float	RO	

40135	Run Hour Meter	32 bit integer	R / W	If the password protection is enabled, enter your password in the "Setting Protection" address and then enter the value "2222" in the "Activating Meter Change" address. Later on, you may enter a value.
40137	On Hour Meter	32 bit integer	RO	
40139	Power interruption meter	32 bit integer	RO	
40141	Import Active Energy	32 bit integer	R / W	If the password protection is enabled, enter your password in the "Settings Protection address and then enter "2222" in the "Enabling Meter Cahnge". Later on, you may enter a value.
40143	Export Active Energy	32 bit integer	R / W	
40145	Import Reactive Energy	32 bit integer	R / W	
40147	Export Reactive Energy	32 bit integer	R / W	

40149	Current transformer ratio (CTR)	32 bit integer	R / W	If the password protection is enabled, you should enter a password in the "Settings Protection" address."
40151	Voltage transformer ratio (VTR)	float	R / W	
40153	Demand Duration	32 bit integer	R / W	
40155	Password activation	32 bit integer	R / W	
40157	Password activation duration	32 bit integer	R / W	
40159	Password value	32 bit integer	R / W	
40161	Baud Rate	32 bit integer	R / W	
40163	Slave ID	32 bit integer	R / W	
40165	Parity control	32 bit integer	R / W	
40167	RESERVE	32 bit integer	R / W	
40169	RESERVE	32 bit integer	R / W	
40171	RESERVE	32 bit integer	R / W	
40173	RESERVE	32 bit integer	R / W	
40175	RESERVE	32 bit integer	R / W	
40177	RESERVE	32 bit integer	R / W	
40179	RESERVE	32 bit integer	R / W	
40181	RESERVE	32 bit integer	R / W	
40183	Menu Browsing On/Off	32 bit integer	R / W	
40185	Menu screening duration	32 bit integer	R / W	
40187	Homepage Setting	32 bit integer	R / W	
40189	Display Backlight Options	32 bit integer	R / W	
40191	Display Backlight On Time	32 bit integer	R / W	
40193	Voltage Alarm Upper Limit	float	R / W	
40195	Voltage Alarm Lower Limit	float	R / W	
40197	Voltage Alarm Hysteresis	float	R / W	
40199	Voltage Alarm Delay Time	32 bit integer	R / W	
40201	Current Alarm Upper Limit	float	R / W	
40203	Current Alarm Lower Limit	float	R / W	
40205	Current Alarm Hysteresis	float	R / W	
40207	Current Alarm Delay Time	32 bit integer	R / W	

40209	Cosφ Alarm Upper Limit	float	R / W	
40211	Cosφ Alarm Lower Limit	float	R / W	
40213	Cosφ Alarm Hysteresis	float	R / W	
40215	Cosφ Alarm Delay Time	32 bit integer	R / W	
40217	Power Factor Alarm Upper Limit	float	R / W	
40219	Power Factor Alarm Lower Limit	float	R / W	
40221	Power Factor Alarm Hysteresis	float	R / W	
40223	Power Factor Alarm Delay Time	32 bit integer	R / W	
40225	Frequency Alarm Upper Limit	float	R / W	
40227	Frequency Alarm Lower Limit	float	R / W	
40229	Frequency Alarm Hysteresis	float	R / W	
40231	Frequency Alarm Delay Time	32 bit integer	R / W	
40233	Device Firmware Version	float	RO	
40235	Device Model	32 bit integer	RO	
40237	Setting Protection	32 bit integer	R / W	The address to enter the device password. While reading via the 03H function, it shows the enabled/disabled status of the password protection.
COMMANDS				
41001	Reset the Energy Values	32 bit integer	WO	If the password protection is enabled, you should enter a password in the "Settings Protection" address. To reset the values, write "1" in the related address. If you write "0" before saving, previous values come back.
41003	Reset the Meter Values	32 bit integer	WO	
41005	Reset the Max values	32 bit integer	WO	
41007	Reset the Minimum Values	32 bit integer	WO	
41009	Reset the demand values	32 bit integer	WO	
41011	Reset the setting	32 bit integer	WO	
41013	Reset the alarm limits	32 bit integer	WO	
41015	Restore the device to the factory settings	32 bit integer	WO	

42001	Save the changes	32 bit integer	WO	If the password protection is enabled, you should enter a password in the "Settings Protection" address. Write "1" to save the changes and restart
45001	Activate the Meter Change	32 bit integer	WO	If the password protection is enabled, you should enter a password in the "Settings Protection" address. To activate the assignment to the meter, you should enter "2222" in this address. If you write "0" in this address, it turns off the meter assignment.

Table 4-1 MODBUS table

4.1 Applying Multiple Option Settings With Modbus

Modbus addresses, values that may be entered and their meaning for multiple option settings are provided below.

address	register name	Value that may be written	description
40155	Password activation	0	OFF
			ON
40161	Baud Rate	0	1200 baud
		1	2400 baud
		2	4800 baud
		3	9600 baud
		4	19200 baud
		5	38400 baud
		6	57600 baud
40165	Parity Control	0	NONE
		1	EVEN
		2	ODD
40183	Menu Browsing On/Off	0	OFF
			ON

40187	Homepage setting	0	VOLTAGE
		1	CURRENT
		2	FREQ
		3	COSQ
		4	PF
		5	POWER P
		6	POWER Q
		7	POWER S
		8	THD V
		9	THD I
40189	Display Backlight Options	0	DURATION DEP
		1	CONT ON
		2	CONT OFF

4.2 Status Flags

“Status Flags” showing the status and alarm status as well as alarm status described in bits and modbus address are shown below.

40125 : Status Flags															
31	30	29	28	27	26	25	24	23	22	21	20	19	18	17	16
Reserve															
15	14	13	12	11	10	9	8	7	6	5	4	3	2	1	0
Reserve				I OFF	V OFF	Freq Low	Freq High	PF Low	PF High	Cosφ Low	Cosφ High	I Low	I High	V Low	V High

bit	description
31 - 12	: Reserve
11	: I OFF – No current in the current channel
10	: V OFF – No voltage in the voltage channel
9	: Freq Low – Low frequency alarm
8	: Freq High – High frequency alarm
7	: PF Low – Low power factor alarm
6	: PF High – High power factor alarm
5	: Cos φ Low - Low Cos φ alarm
4	: Cos φ High - High Cos φ alarm
3	: I Low - Low current alarm
2	: I High – High current alarm
1	: V Low - Low phase-neutral voltage alarm
0	: V High – High phase-neutral voltage alarm



POWYS
Energy Analyzer

**SECTION 5
FACTORY
PREVALUES AND
SETTING
RANGES**



SECTION 5 Factory Prevalues and Setting Ranges

Menu	Submenu 1	Submenu 2	Description	Prevalue	Unit	Setting Range
BASIC (bSc)	Ctr		Current transformer ratio	1	-	1 - 5000
	Utr		Voltage transformer ratio	1.0	-	0.1 - 5000.0
ALARMS (ALr)	V ALM (Uolt)	HI	Voltage alarm upper limit	0.0	V	0.0 - 1500000.0
		LO	Voltage alarm lower limit	0.0	V	0.0 - 1500000.0
		hYSt	Voltage alarm hysteresis value	5.0	V	0.0 - 1500000.0
		dIY.t	Voltage alarm delay time	5	sn	0 - 60
	I ALM (Curr)	HI	Current alarm upper limit	0.0	A	0.0 - 30000.0
		LO	Current alarm lower limit	0.0	A	0.0 - 30000.0
		hYSt	Current alarm hysteresis value	0.1	A	0.0 - 30000.0
		dIY.t	Current alarm delay time	5	sn	0 - 60
	COSQ ALM (coSQ)	HI	cos ϕ alarmv upper limit	0.00	-	0.00 - 1.00
		LO	cos ϕ alarm lower limit	0.00	-	0.00 - 1.00
		hYSt	cos ϕ alarm hysteresis value	0.01	-	0.00 - 1.00
		dIY.t	cos ϕ alarm delay time	5	sn	0 - 60

	PF ALM (PF)	HI	Power factor alarm upper limit	0.00	-	0.00 - 1.00
		LO	Power factor alarm lower limit	0.00	-	0.00 - 1.00
		hYSt	Power factor alarm hysteresis value	0.01	-	0.00 - 1.00
		dLY.t	Power factor alarm delay time	5	sn	0 - 60
	FREQ ALM (FrEq)	HI	Frequency alarm upper limit	50.0	Hz	45.0 - 65.0
		LO	Frequency alarm lower limit	50.0	Hz	45.0 - 65.0
		hYSt	Frequency alarm hysteresis value	2.0	Hz	0.0 - 20.0
		dLY.t	Frequency alarm delay time	5	sn	0 - 60
DEMAND (dEd)	dEd.t		Demand time setting	15	dk	1 - 60
RS485 (485)	bAud		Baud rate options	38400	Baud	1200 / 2400 / 4800 / 9600 / 19200 / 38400 / 57600
	Id		Slave ID setting	1	-	1 - 247
	PrtY		Parity control setting	NONE (nOnE)	-	NONE / EVEN / ODD
DIG OUT (dOut)	OUT1 (Out1)	tYPE	1st digital output options	OFF	-	OFF / PULSE / LOW ALM / HIGH ALM
	OUT2 (Out2)	tYPE	1st digital output options	OFF	-	OFF / PULSE / LOW ALM / HIGH ALM

PULSE (PuLS)	OUT1 (Out1)	out	1st pulse output parameter setting	OFF	-	OFF / IMP ACT / EXP ACT / IMP REA / EXP REA
		durA	Pulse duration of the 1st pulse output	50	msn	50 - 2500
		rAt	1st pulse output step range	1	Wh / Varh Powys1023 kWh / kVarh	1 - 99 999 999
	OUT2 (Out2)	out	2nd pulse output parameter setting	OFF	-	OFF / IMP ACT / EXP ACT / IMP REA / EXP REA
		durA	Pulse duration of the 2nd pulse output	50	msn	50 - 2500
		rAt	2nd pulse output step range	1	Wh / Varh Powys1023 kWh / kVarh	1 - 99 999 999
SECURITY (Pln)	Act		Enable/disable password protection	NO	-	NO / YES
	Pin.t		Password protection timeout duration	10	min	1 - 60
	Pin		Password change	1	-	1 - 9999
DISPLAY (dISP)	MENU	ScrL	Menu browsing setting	OFF	-	OFF / ON
		Scr.P	Menu screening duration	3	sec	1 - 60
		Strt	Homepage setting	VOLTAGE	-	VOLTAGE / CURRENT / FREQ / COSQ / PF / POWER P / POWER Q / POWER S / THD V / THD I
	BACKLGH	oPt	Display backlight options	DURATION DEP	-	DURATION DEP / CONT ON / CONT OFF
		durA	Display backlight on duration	600	sec	10 - 600

CLEAR (CLr)	CLr		Clear menu	OFF	-	OFF / ALL / ENERGY / COUNTERS / MAX VALS / MIN VALS / DEMANDS / SETTINGS / ALARMS
----------------	-----	--	------------	-----	---	---

Table 5-1 Factory Prevalu



POWYS
Energy Analyzer

**SECTION 6
TECHNICAL
SPECIFICATIONS**

SECTION 6 Technical Specification

SUPPLY	
Voltage	85..300 V AC/DC
Frequency	45..65Hz
Power Consumption	< 2W
MEASUREMENT INPUT	
Voltage	10..500V AC
Current	10mA .. 6A AC
Frequency	45..65Hz
DIGITAL OUTPUT	
Output Type	Transistor
Switching Voltage	5..30V DC
Maximum Switching Current	50mA
Isolation	3750V RMS
	50mA
COMMUNICATION	
Baudrate Setting	1200 - 2400 - 4800 - 9600 - 19200 - 38400 - 57600
Isolation	1500V RMS
	50mA
GENERAL	
Operating Temperature	-20°C..+70°C
Storage Temperature	-30°C..+80°C
Protection Class	IP40 (Front Panel), IP20 (Terminals)
Relative Humidity	95% without condensation

Table 6-1 Measurement Accuracy

Measurement Accuracy				
Symbol	Description	Class According to IEC 61557-12	Measurement Range	Other Standards
P	Total Active Power	0,5	10% $I_b \leq I \leq I_{max}$ 0,5 Ind to 0,8 Cap	-
QV	Total Reactive Power	1	5% $I_b \leq I \leq I_{max}$ 0,25 Ind to 0,25 Cap	-
SA	Total Apparent Power	0,5	10% $I_b \leq I \leq I_{max}$ 0,5 Ind to 0,8 Cap	-
EA	Total Reactive Power	0,5	0 to 99999999 kWh 0 to 9999999,9 kWh (POWYS1023)	IEC 62053-22 Class 0,55
ErV	Total Reactive Energy	2	0 to 99999999 kVarh 0 to 9999999,9 kVarh (POWYS1023)	IEC 62053-23 Class 2
f	Frequency	0,1	45-65 Hz	-
I	Phase Current	0,5	20% $I_b \leq I \leq I_{max}$	-
INc	Neutral Current (Measured)	0,5	20% $I_b \leq I \leq I_{max}$	-
U	Voltage	0,2	$U_{min} \leq U \leq U_{max}$	-
PFA	Power Factor	0,5	0,5 Ind to 0,8 Cap	-
THDV	Total Harmonic Distortion Voltage	1	0 % to 20 %	-
THDI	Total Harmonic Distortion Current	1	0 % to 100 %	-

